

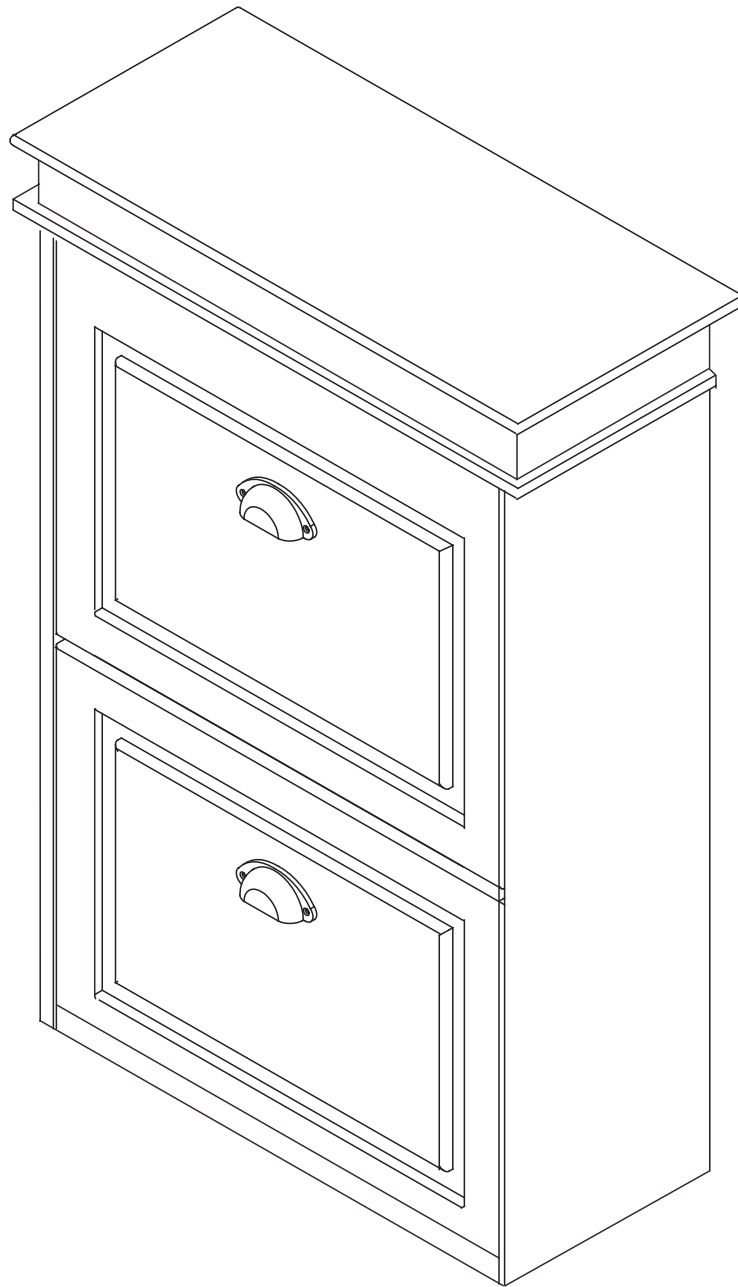

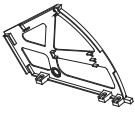









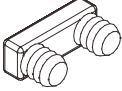



SEBER TYP 1

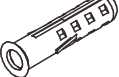
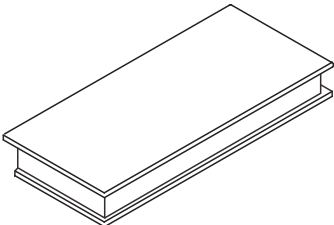

<p>Ax2</p> 	<p>Bx2</p> 	<p>Cx8</p> 	<p>Dx8</p> 
<p>Ex4</p> 	<p>Fx4</p> 	<p>Gx6</p> 	<p>Hx2</p> 
<p>Ix4</p>  <p>4x12mm</p>	<p>Jx4</p>  <p>4x12mm</p>	<p>Kx24</p>  <p>3x16mm</p>	<p>Lx1</p> 
<p>Mx16</p>  <p>2.5x10mm</p>	<p>Nx1</p>  <p>4x12mm</p>	<p>Ox1</p>  <p>4x40mm</p>	<p>Px1</p> 

<p>1x1</p> 	<p>2x1</p> 	<p>3x1</p> 
<p>4x2</p> 	<p>5x1</p> 	<p>6x1</p> 
<p>7x2</p> 	<p>8x4</p> 	<p>9x2</p> 

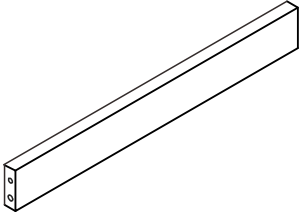
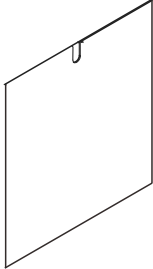
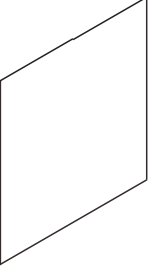
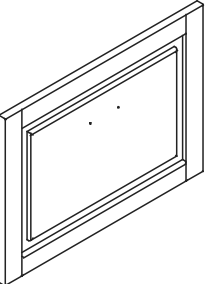
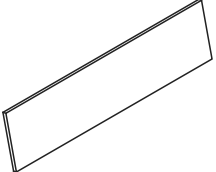
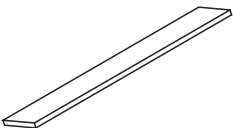
1

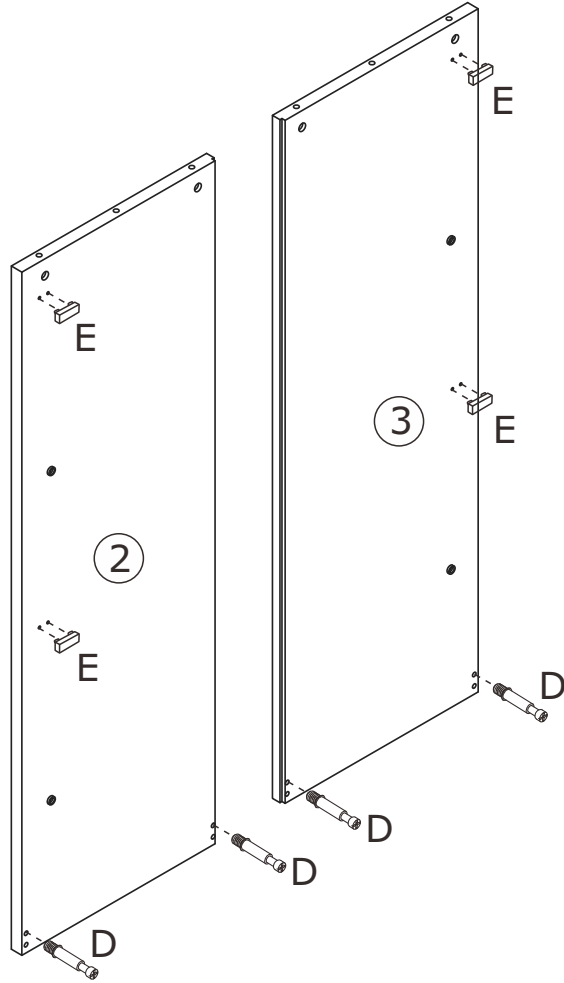

2

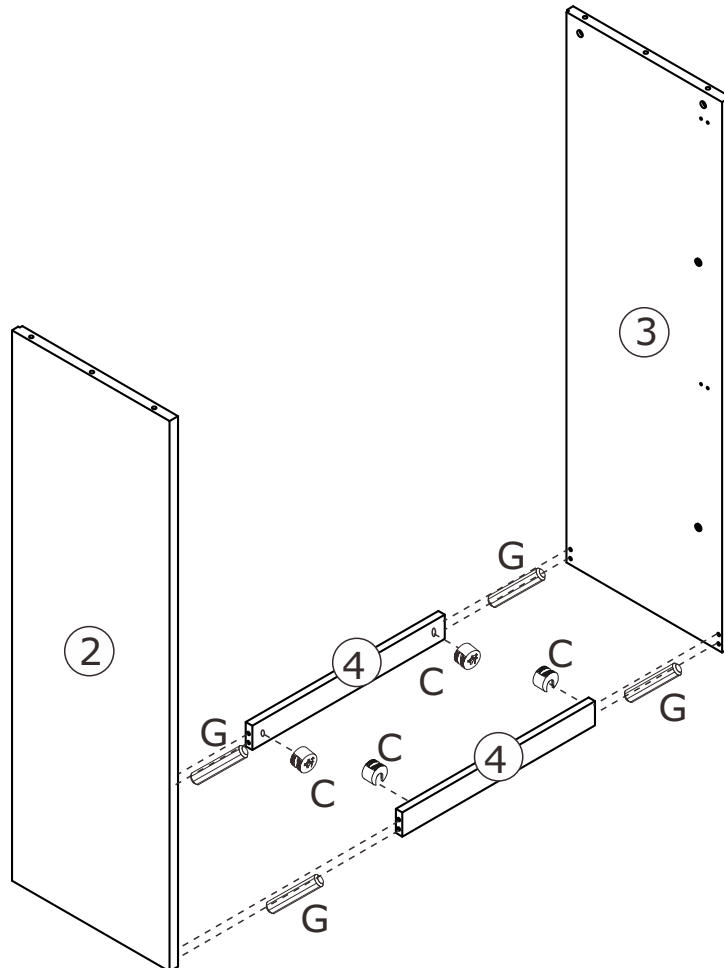

3

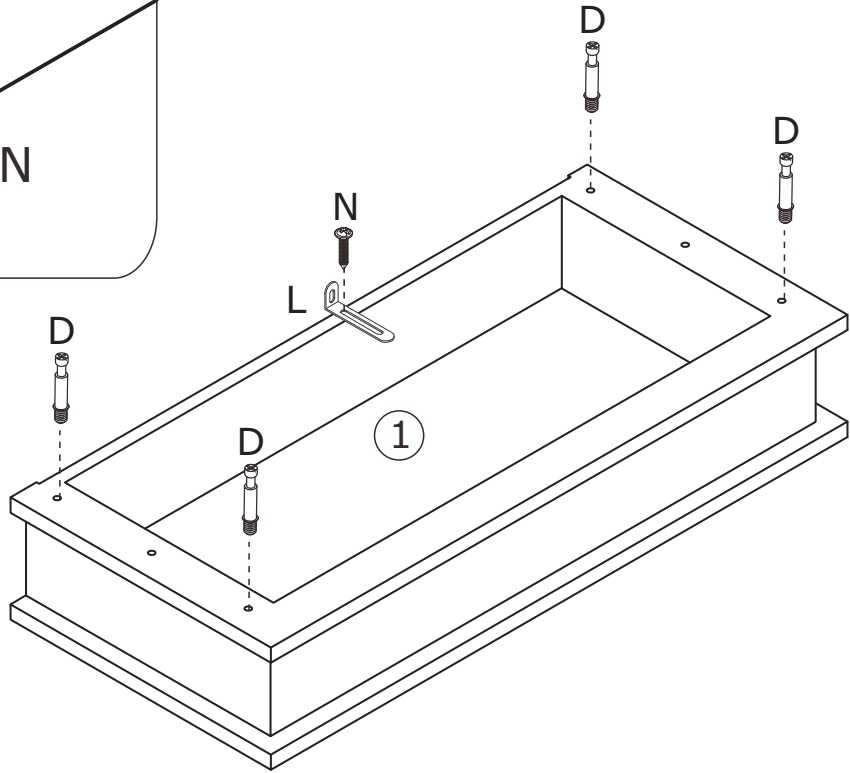
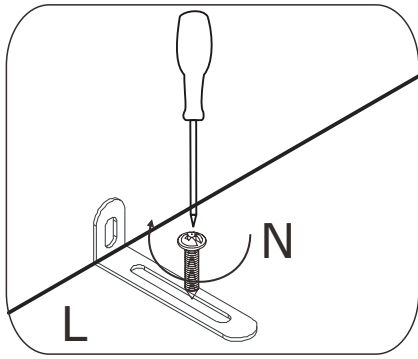

4

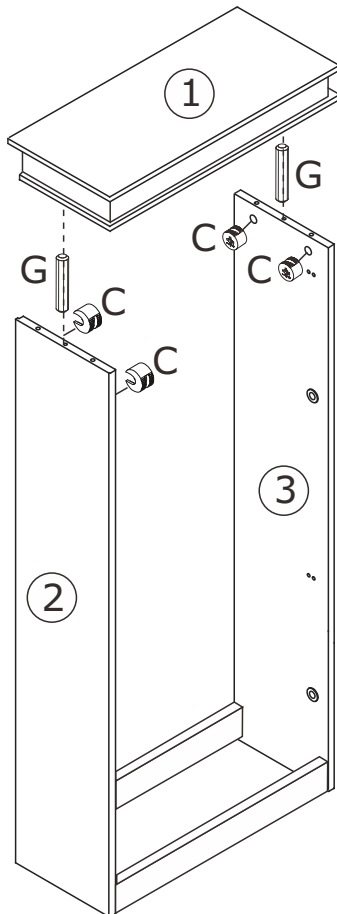

5

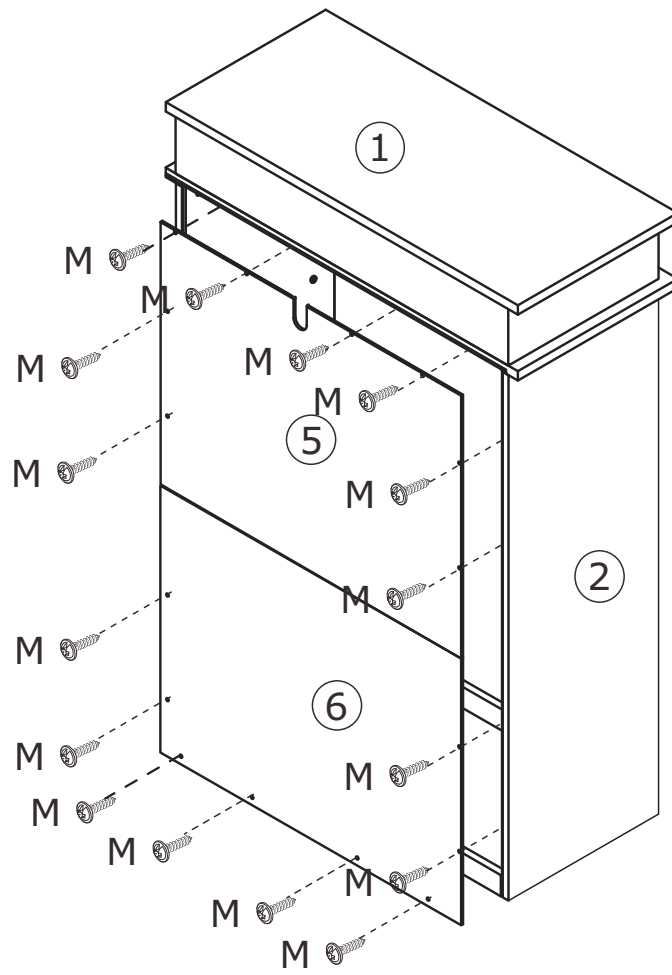

6

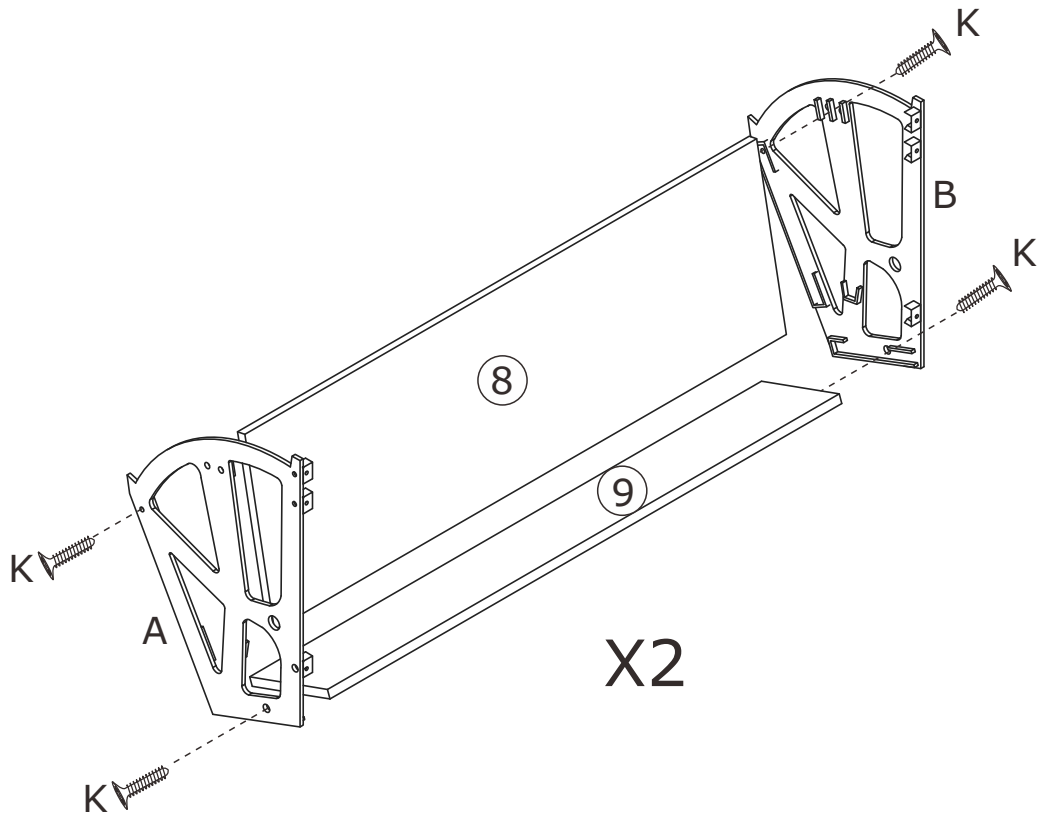

7

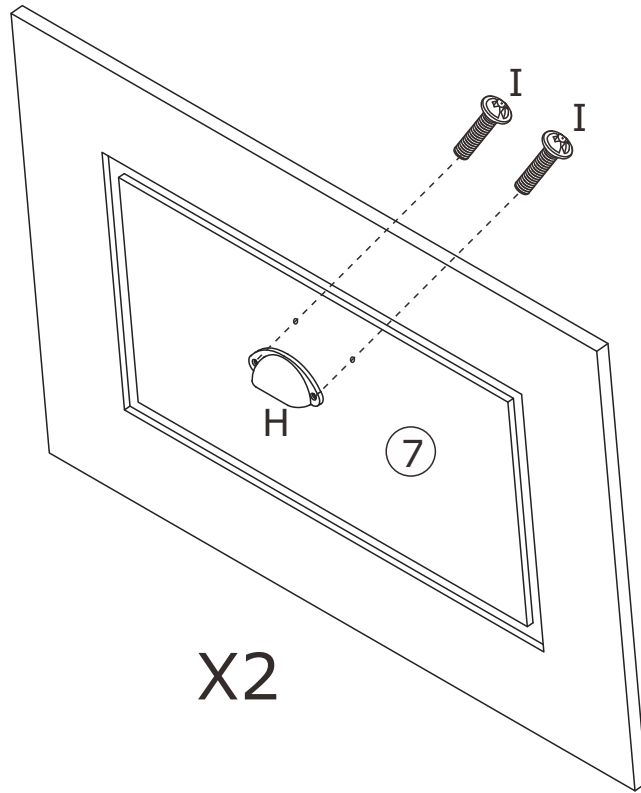

X2

8

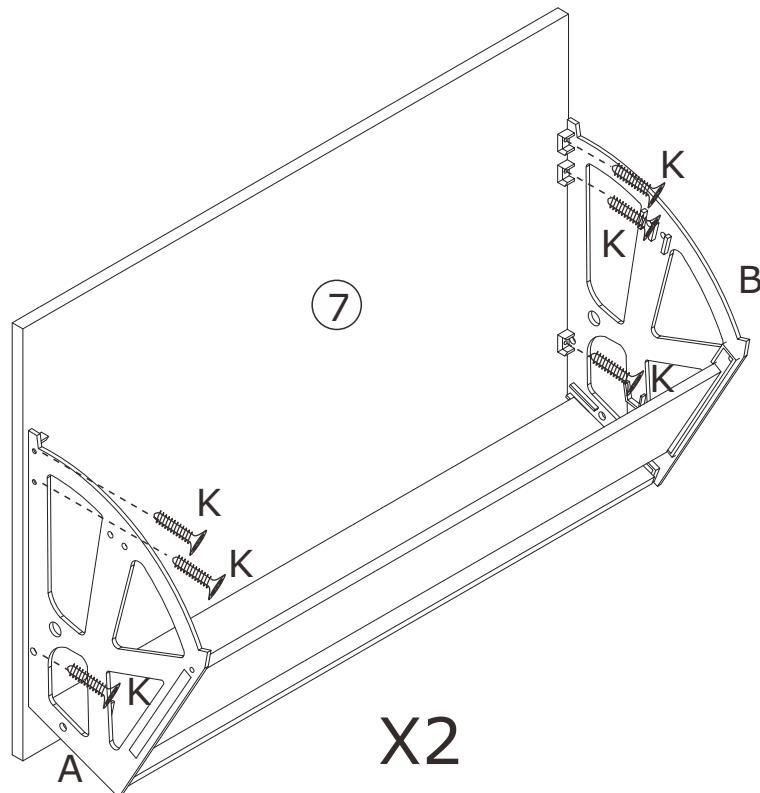

X2

9

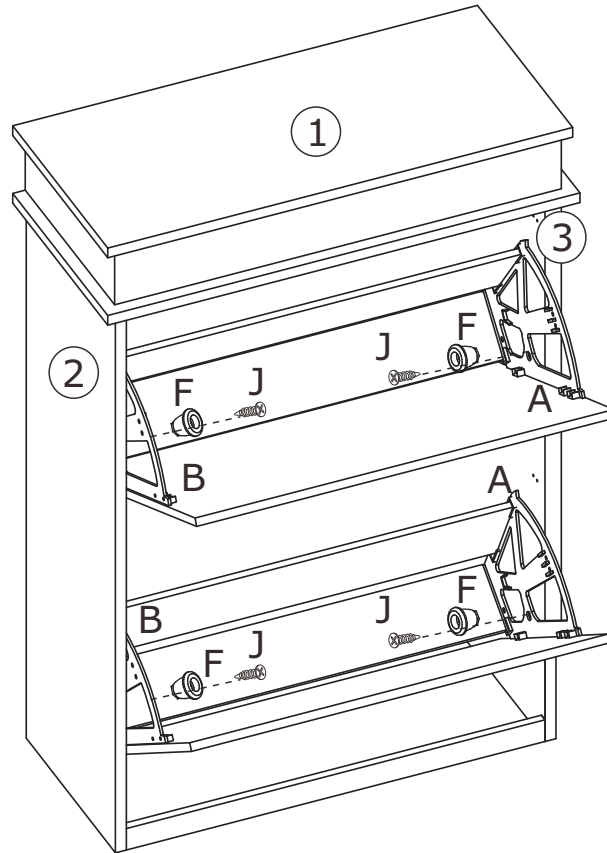

10

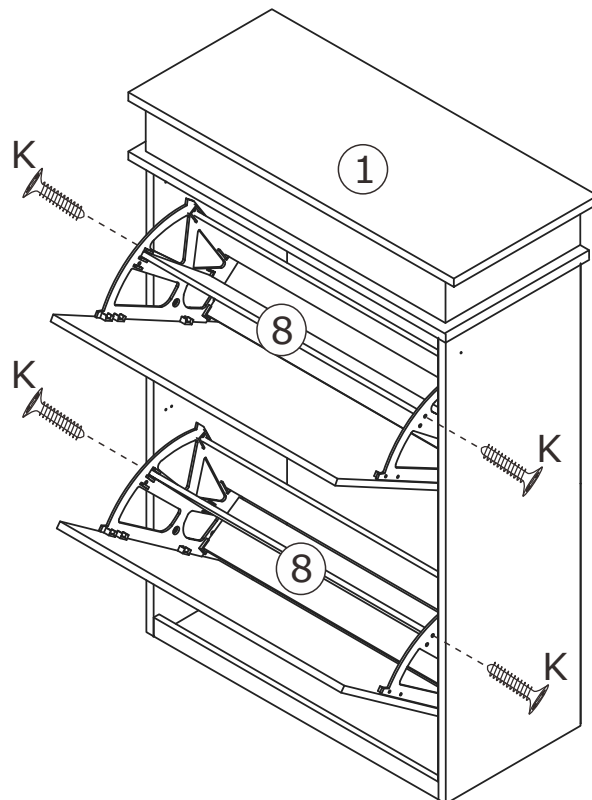

11

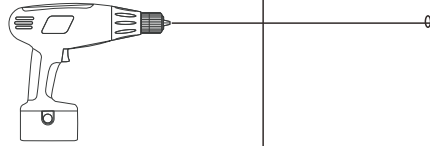

12

